

NEW APPROACH FOR THE STEP-UP CONVERTER EFFICIENCY INCREASING

Abstract. This paper is devoted to the problem of efficient power conversion technologies creation. New approach for step-up converter gate driver powering is proposed. Experimental and numerical researches for new method were conducted. Results give us both good confirmation of the new schematic advantages and usage limitations. Different power loss streams are considered.

Keywords: energy efficiency, power loss, DC/DC converter, electronic simulation.

Statement of the problem. Ensuring energy efficiency is one of the highest priority tasks in the design of both industrial and computer technology. In turn, modern devices often requires several different supply voltages for its operation. For example, desktop computer mainboard requires +12V, +5V, +3.3V power rails, not counting to numerous internal power converters and power rails for signal interfaces. Some laboratory and industrial equipment require high-power controlled source [8,9].

Direct conversion from AC power line to every required DC rail in many cases is a costly and resource consuming solution. So, to provide different DC sources power converters are used. One of the most frequently used converters is a so called DC/DC converter.

There are many topologies, schematics and integrated components for this class of converters [1–3]. Some of the solutions are based on discrete components, other requires modern and complex integrated components, which uses outstanding methods to provide high energy efficiency, low noise and other desirable features [2,4,7].

In spite of the existence of the modern integrated components for the DC/DC conversion task, usage of the simple schematics and components may be considered as applicable solution. First of all, special requirements of the laboratory equipment may make modern solutions useless. On the other hand, modern components may be unavailable or too costly.

So, the task of creation, simulations and research in the area of DC/DC converters synthesis is actual both scientific and technological point of view.

In this paper the task of step-up converter energy efficiency improving is under consideration. Especial attention is paid for experimental justification for the predicted results, as well as for cheap and available components usage.

Analysis of recent research and publications. Due to exceptional actuality, there are huge amount of the researches, book and articles concerning DC/DC converters. Some of them is mainly focused on the theory questions [1,5,6], other - gives us ready to use solutions [2-4]. Nevertheless, none of them gives us a methods for the energy efficiency improving with simple schematics and available components.

Methods of the buck converter control, and corresponding models, which was proposed in papers [8,9], is not applicable to the step-up converter. Moreover, the energy efficiency questions was not under consideration there.

Purpose of the study. This article sets out the following main objectives.

Provide a simple method for the step-up converter energy efficiency improvement, without usage of the bleeding-edge components.

Explore the characteristics the proposed method and schematic properties.

Establish the bounds of the applicability for the proposed solution.

Statement of the main research material. There are many reasons for energy leaking in impulse DC/DC converters. It is worth to mention losses in magnetic cores, capacitors and other passive elements. But there is common element and common losses reason in these converters – switching element (or elements). In modern converters these elements are represented by MOSFET or IGBT. In general, these transistors provide low resistance in the "open" state (R_{ds}), approximately 10-2 Ohm. But to achieve such prominent results, some conditions must be met.

First of all, sufficient gate voltage V_g must be provided. Moreover, higher frequencies requires essential current to charge gate at small time. To met these conditions, special gate drivers exists and used widely in powerful converters.

Step-up (or "burst") converters have some essential penalty in comparison with step-down ("buck") converters. Lower input voltage leads to lower gate voltage in the "on" state. This may lead to source-drain resistance rising, as well as lower value of the front slope. As consequence, the overall energy loss level is increasing.

Modern integrated converters can mitigate this drawback by the internal charge pump usage. But, as it was mentioned before, such approaches is not always applicable.

In this paper another approach is proposed. In the initial state, input voltage (V_{in}) is used for the gate driver powering. After the start-up, when output voltage

(V_o) become greater, than the input one, it become the source for the driver. Generally, driver power consumption is essentially lesser, when output power. So, Schottky diodes may be used as a switch between input and output schematic branches for driver powering.

In the figure 1 the test schematic for the proposed method is represented.

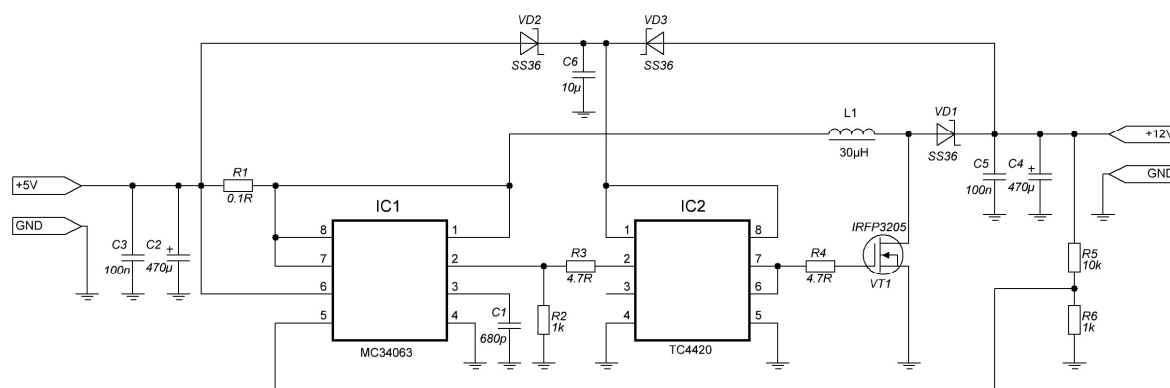

Figure 1 – Test schematic for the proposed approach with dual gate driver powering

Well-known and somewhat ancient integrated schematic IC1 MC34063A is used as switching signal source. It also realizes feedback for output voltage stabilization and over current protection. Widely used IC2 TC4420 provides gate charge and discharge current for the main switching element – VT1 IRFP3205. This MOSFET is somewhat more powerful, that required for this purpose, but this choice can emphasize advantages and drawbacks of the new approach.

As it was proposed before, a pair of the Schottky diodes (VD2 and VD3) is used to power gate driver. For the test purpose, there is a jumper (not shown in the schematic) to disable VD3. Later, data from the schematics with both diodes will be labeled as “2 diodes”, and “1 diode” – with disable VD3.

Capacitor C6 provides stabilization of the gate driver voltage (V_p), taking in the account impulsive nature of the load.

First of all, a series on experiments was held to prove the proposed method applicability. A set of resistors was used as load (R_L) with and without VD3. For every resistor input current (I_{in}) and output voltage (V_o) was measured by digital multimeters. Input voltage was stabilized by the external programming power source, whereas output current was determined by resistor. Resistors was tested for temperature stability. Measurement time was large enough to provide readings stabilization, but small enough to not overheat equipment.

In the figure 2 the quality of output voltage stabilization is represented.

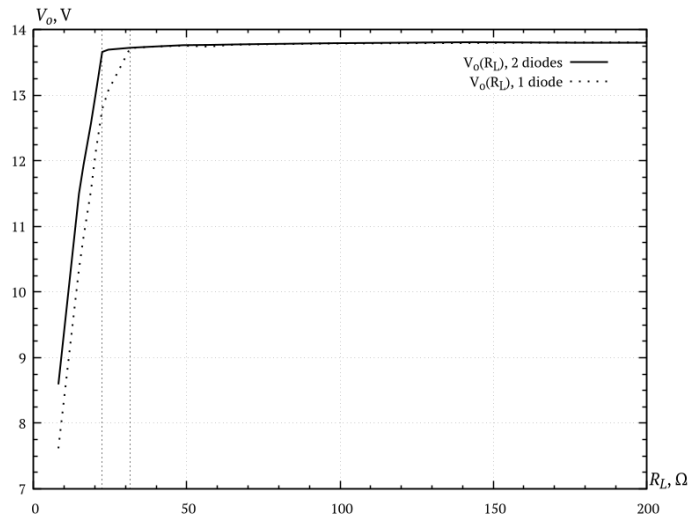

Figure 2 - Output voltage stabilization quality in dependence of load

In the most of the user R_L range stabilization voltage was the same, as in low load condition it defined by the voltage feedback subcircuit. But in the case of lesser R_L values, and higher load, schematic without VD3 fails to stabilize output voltage some earlier. At first sight, this difference seems negligible, but it corresponds up to 25% output power.

Figure 3 represents main result of this experiment – dependence of the converter efficiency from the load.

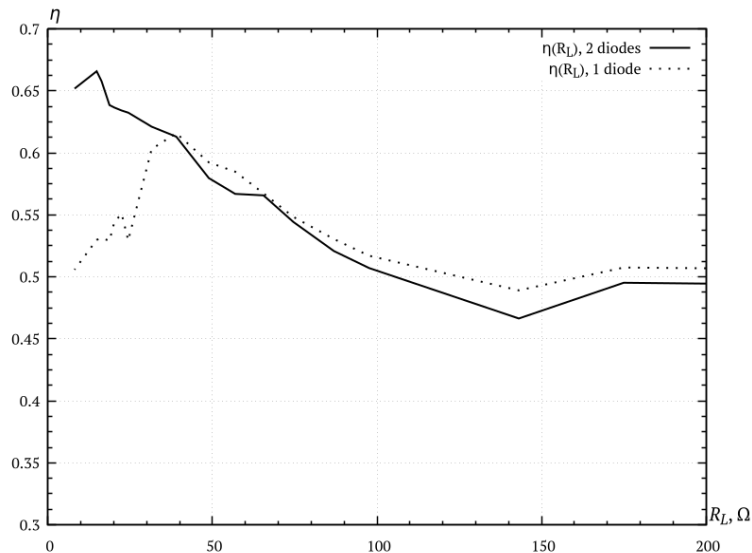

Figure 3 - dependence of the converter efficiency from the load

In this figure we can observe some surprising result. In the essential part of the R_L range the efficiency with VD3 is lesser. This is opposite to the expected results. But in the area of higher loads, new approach show better results - as expected. Namely this area is essential to common usage of the converter, but additional researches was held to find justification for the phenomena.

One more phenomena was detected during these experiments. In the condition of high load, the output voltage stabilization time without VD3 becomes extremely high – up to 20 s. On the other hand, schematic with proposed approach stabilizes voltage less then in 1 s. This fact emphasizes the new method advantages under high load.

In the figure 4 the dependencies $V_g(t)$ and $V_L(t)$ in the case of essential load ($R_L=24.4 \text{ Ohm}$) are presented. It is obvious, that gate voltage level in the schematic with VD3 is near to output voltage. This leads to lesser energy loss, and consequently, lesser heating of the switch transistor.

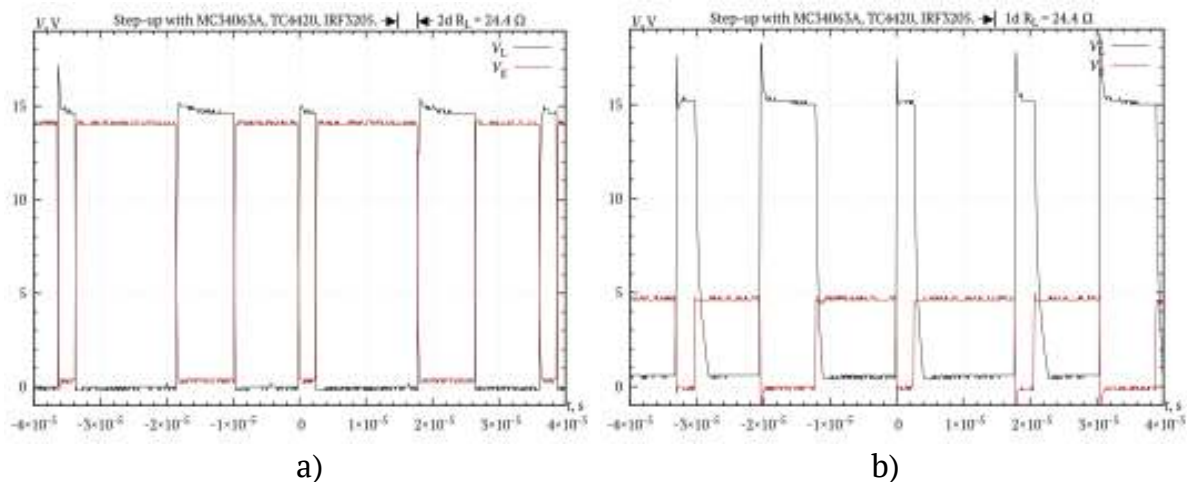

Figure 4 – Dependencies $V_g(t)$ and $V_L(t)$ with (a) and without (b) VD3

In the figure 5 start-up condition dependencies of output and driver power voltage ($V_p(t)$) are presented. New schematic provides both gate driver power switching from V_{in} to V_o , and significantly faster output voltage stabilization. Moreover, it is impossible to visualize correctly both processes in the same scale.

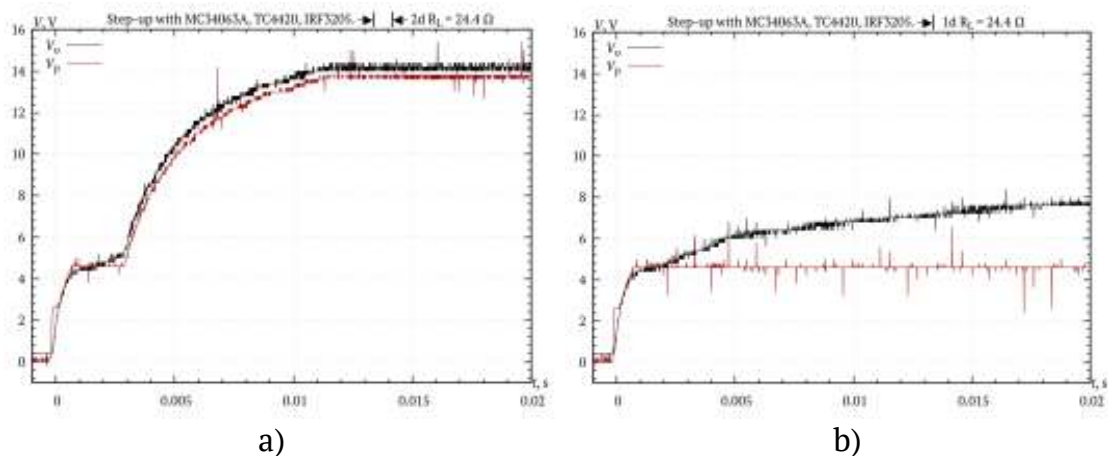

Figure 5 – start-up condition dependencies of output and driver power voltage ($V_p(t)$) with (a) and without (b) VD3

To determine the reason of the surprising result, 2 factors was investigated.

First - the source of power loss via switching element was investigated. For this purpose the R_{ds} value was measured in static condition. Results are represented in the fig. 6. This results show essential difference in R_{ds} value under conditions $V_{dd}=V_p = 4.6 \text{ V}$ (without VD3) and $V_{dd}=V_p=13.8 \text{ V}$ (with VD3). Unfortunately, this experiment ignores losses due to lesser from slope value. This influence requires additions experiments.

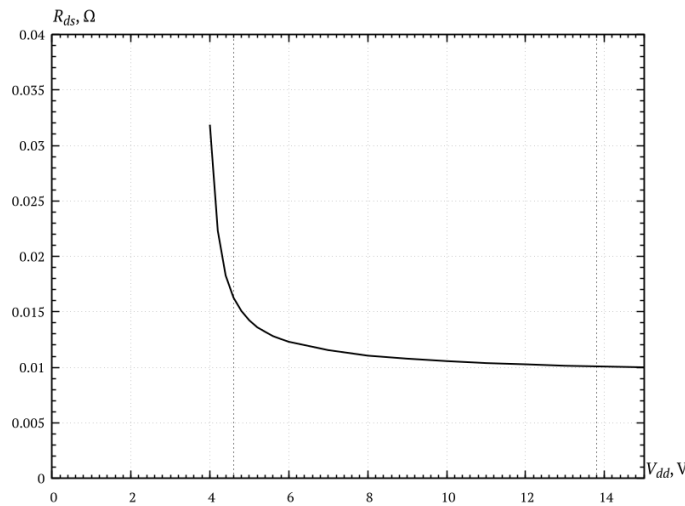

Figure 6 – Experimental $R_{ds}(V_{dd})$ dependence

Better $V_g(t)$ control means high costs for this control. This phenomena may explain surprising results.

The next group of experiments was held to measure losses to control in dependence from V_p and switching frequency f (fig. 7). Measurements of question current (I_q) was held without load and with constant duty factor. These limitations allows up only to estimate power loss due to control.

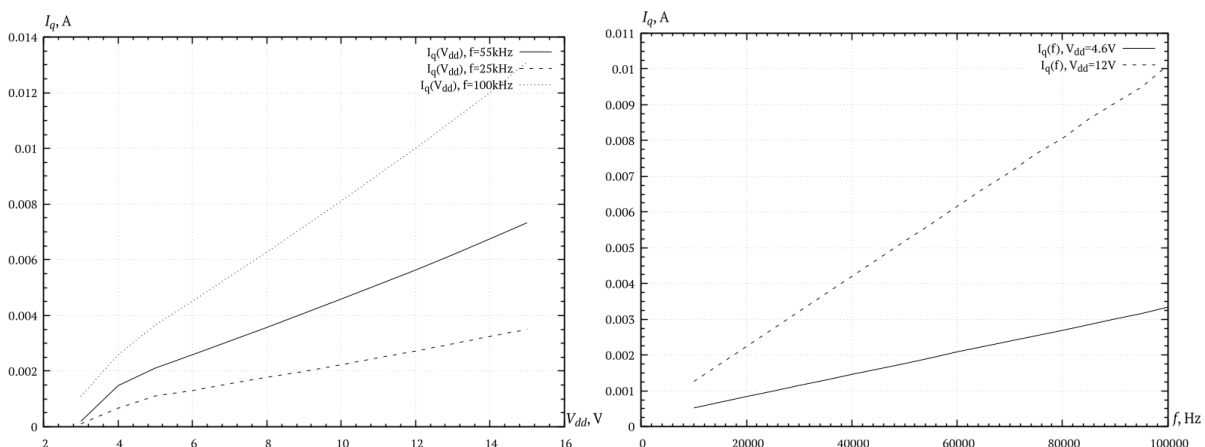

Figure 7 - Dependencies $I_q(V_{dd})$ (a) and $I_q(f)$

Measurements shows, that Iq in the working range is nearly linear both on Vp and f. So, it is confirmed, that better control requires more power, and in the case of low total power consumption influence of this part will be at least noticeable.

Findings. The results of the experiments and simulations allows us to give such conclusions.

1. Proposed approach really provides better power efficiency in the case of high load.

2. Using this approach on lower loads may be useless due to control power rising.

3. Precise working range can not be determined only by calculations, as too many effects influenced to result.

REFERENCES

1. Keng C. Wu. Switch-Mode Power Converters / Elsevier Academic Press – 2006. – 409 p.
2. Markus Zehendner, Matthias Ulmann. Power Topologies Handbook // Texas Instruments. – 2021 – 199 p.
3. The power electronics handbook. Edited by timothy l. Skvarenina / Purdue University West Lafayette, Indiana – 2002 – 625 p.
4. Steve Roberts DC/DC book of knowledge / Steve Roberts // RECOM Group Gmunden 2014. – 234 p.
5. Marian K. Kazimierczuk Pulse-Width Modulated DC-DC Power Converters, 2nd Edition / Marian K. Kazimierczuk // Wright State University, Dayton, Ohio, USA 2008 – 960 p.
6. Robert W. Erickson Fundamentals of Power Electronics / Robert W. Erickson, Dragan Maksimovic / University of Cololrado Boulder, USA 1997 – 881 p.
7. Blaabjerg, F.; Chen, Z.; Kj.r, S.B. Power electronics as efficient interface in dispersed power generation systems. IEEE Trans. Pow. Electron. 2004, 19, 1184–1194.
8. A.Yu. Zimoglyad. Development of a system for thermal evaporation / Zimoglyad A.Yu. , Guda A.I. // Regional interuniversity compendium of scientific works – 2019. – №6 (119). – P. 3–11.
9. A.Yu. Zimoglyad. Buck converter simulation and measurement / Zimoglyad A.Yu. , Guda A.I. // System technologies. Regional interuniversity compendium of scientific works – 2019. – №2 (121). – P. 21–32.

Received 19.03.2021.
Accepted 23.03.2021.

Новий підхід до підвищення ефективності step-up перетворювача

Ця стаття присвячена проблемі створення ефективних технологій перетворення енергії. Основними цілями статті є: запропонувати простий метод для підвищення енергоефективності перетворювача, що не перевищує ефективність, без використання передових компонентів, дослідити характеристики запропонованого методу та схематичні властивості, а також встановити межі застосовності для запропонованого рішення.

У цій роботі пропонується інший підхід. У початковому стані вхідна напруга використовується для живлення драйвера затвора. Після запуску, коли вихідна напруга стає більше, ніж вхідна, вона стає джерелом для драйвера. Діоди Шоттки можуть використовуватися як перемикач між вхідними та вихідними схематичними гілками для живлення драйвера.

Створено експериментальний підрозділ для перевірки нового підходу. В основі - мікросхема MC34063A, TC4420, MOSFET IRFP3205 та інші компоненти. Для визначення нових властивостей підходу була проведена серія експериментів. Порівняння з класичним методом посилення виявляє різницю між підходом.

Експерименти показують, що у випадку великого навантаження класична схема не вдається стабілізувати вихідну напругу дещо раніше, ніж запропонований спосіб. У тих же умовах енергоефективність може бути вищою до 15%. З іншого боку, через збільшення втрат потужності в ланцюзі управління цей метод має трохи меншу ефективність у випадку низького навантаження.

Чисельна оцінка властивостей нового методу разом із експериментальними результатами забезпечує основу для правильного вибору підходу. Деякі розбіжності між теорією та експериментами вимагають подальших досліджень.

Запропонований підхід дійсно забезпечує кращу енергоефективність у разі великих навантажень, але використання цього підходу на менших навантаженнях може виявитися марним через збільшення потужності управління. Точний робочий діапазон неможливо визначити лише розрахунками, необхідні експерименти.

New approach for the step-up converter efficiency increasing

This paper is devoted to the problem of efficient power conversion technologies creation. The main article objectives are: provide a simple method for the step-up converter energy efficiency improvement, without usage of the bleeding-edge components, explore the characteristics the proposed method and schematic properties, and to establish the bounds of the applicability for the proposed solution.

In this paper an another approach is proposed. In the initial state, input voltage is used for the gate driver powering. After the start-up, when output voltage become greater, than the input one, it become the source for the driver. Schottky diodes may be used as a switch between input and output schematic branches for driver powering.

Experimental unit to test new approach was created. It is base on IC MC34063A, TC4420, MOSFET IRFP3205 and other components. A series of experiments was held to determine new

approach properties. Comparison with classic step-up method reveals difference between approach.

Experiments shows, that in the case of high load, classic schematic fails to stabilize output voltage some earlier, than proposed method. In the same conditions power efficiency may be higher up to 15 %. On the other hand, due to increasing power loss in control circuit this method has slightly lesser efficiency in the case low load.

Numerical estimation of new method properties, along with experimental results provides background for correct approach selection. Some discrepancies between theory and experiments requires further investigation.

Proposed approach really provides better power efficiency in the case of high load, but using this approach on lower loads may be useless due to control power rising. Precise working range can not be determined only by calculations, experiments are required.

Гуда Антон Ігорович – д.т.н, проф., доц. каф ІТС НМетАУ.

Зимогляд Андрій Юрійович – к.т.н., асс. каф. ІТС НМетАУ.

Гуда Антон Игоревич – д.т.н, проф., доц. каф ИТС НМетАУ.

Зимогляд Андрей Юрьевич – к.т.н., асс. каф. ИТС НМетАУ.

Guda Anton – doctor of technical sciences, professor, docent Department of information technology and systems.

Zimoglyad Andrey – candidate of technical science, assistant Department of information technology and systems.